

2A 1-Cell Li+ DC-DC Charger for USB* and Adapter Power

General Description

The MAX8903A is an integrated 1-cell Li+ charger and Smart Power Selector™ with dual (AC adapter and USB) power inputs. The switch mode charger uses a high switching frequency to eliminate heat and allow tiny external components. It can operate with either separate inputs for USB and AC adapter power, or from a single input that accepts both. All power switches for charging and switching the load between battery and external power are included on-chip. No external MOSFETs, blocking diodes, or current-sense resistors are required.

The MAX8903A features optimized smart power control to make the best use of limited USB or adapter power. Battery charge current and SYS output current limit are independently set. Power not used by the system charges the battery. Charge current and SYS output current limit can be set up to 2A while USB input current can be set to 100mA or 500mA. Automatic input selection switches the system from battery to external power. The DC input operates from 4.15V to 16V with up to 20V protection, while the USB input has a range of 4.1V to 6.3V with up to 8V protection.

The MAX8903A internally blocks current from the battery and system back to the DC and USB inputs when no input supply is present. Other features include pre-qual charging and timer, fast charge timer, overvoltage protection, charge status and fault outputs, power-OK monitors, and a battery thermistor monitor. In addition, on-chip thermal limiting reduces battery charge rate and AC adapter current to prevent charger overheating. The MAX8903A is available in a 4mm x 4mm, 28-pin thin QFN package.

Applications

PDA's, Palmtops, and Wireless Handhelds
Personal Navigation Devices
Smart Cell Phones
Portable Multimedia Players
Mobile Internet Devices
Ultra Mobile PCs

*Protected by US Patent #6,507,172.

Smart Power Selector is a trademark of Maxim Integrated Products, Inc.

Features

- ◆ Efficient DC-DC Converter Eliminates Heat
- ◆ 4MHz Switching for Tiny External Components
- ◆ Instant On—Works with No Battery or Low Battery
- ◆ Dual Current-Limiting Input Circuits—AC Adapter or USB
 - Automatic Adapter/USB/Battery Switchover to Support Load Transients
 - 50mΩ System-to-Battery Switch Supports USB Spec
- ◆ Thermistor Monitor
- ◆ Integrated Current-Sense Resistor
- ◆ No External MOSFETS or Diodes
- ◆ 4.1V to 16V Input Operating Voltage Range

Ordering Information

PART	TEMP RANGE	PIN-PACKAGE
MAX8903AETI+	-40°C to +85°C	28 Thin QFN-EP**

+ Denotes a lead(Pb)-free/RoHS-compliant package.

**EP = Exposed pad.

Typical Operating Circuit

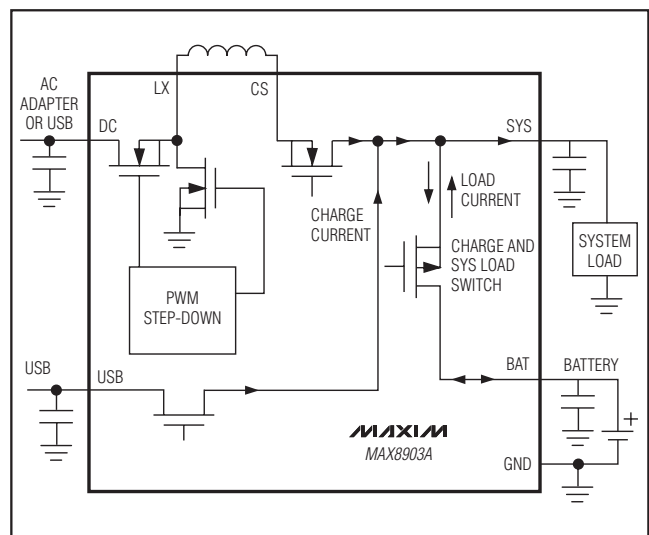

Pin Configuration appears at end of data sheet.

2A 1-Cell Li+ DC-DC Charger for USB* and Adapter Power

ABSOLUTE MAXIMUM RATINGS

DC, LX, DCM to GND	-0.3V to +20V
DC to SYS	-6V to +20V
BST to GND	-0.3V to +26V
BST TO LX	-0.3V to +6V
USB to GND	-0.3V to +9V
USB to SYS	-6V to +9V
VL to GND	-0.3V to +6V
THM, IDC, ISET, CT to GND	-0.3V to (VL + 0.3V)
DOK, FLT, CEN, UOK, CHG, USUS, BAT, SYS, IUSB, CS to GND	-0.3V to +6V
SYS to BAT	-0.3V to +6V
PG, EP (exposed pad) to GND	-0.3V to +0.3V
DC Continuous Current (total in two pins)	2.4A _{RMS}
USB Continuous Current	1.6A

LX Continuous Current (total in two pins)	2.4A _{RMS}
CS Continuous Current (total in two pins)	2.4A _{RMS}
SYS Continuous Current (total in two pins)	3A _{RMS}
BAT Continuous Current (total in two pins)	3A _{RMS}
Continuous Power Dissipation (T _A = +70°C)	
28-Pin Thin QFN-EP	
Multilayer (derate 28.6mW/°C above +70°C)	2286mW
28-Pin Thin QFN-EP	
Single-Layer (derate 20.8mW/°C above +70°C)	1666.7mW
Operating Temperature Range	-40°C to +85°C
Junction Temperature Range	-40°C to +150°C
Storage Temperature Range	-65°C to +150°C
Lead Temperature (soldering, 10s)	+300°C

Stresses beyond those listed under "Absolute Maximum Ratings" may cause permanent damage to the device. These are stress ratings only, and functional operation of the device at these or any other conditions beyond those indicated in the operational sections of the specifications is not implied. Exposure to absolute maximum rating conditions for extended periods may affect device reliability.

ELECTRICAL CHARACTERISTICS

(V_{DC} = V_{USB} = 5V, V_{BAT} = 4V, circuit of Figure 2, T_A = -40°C to +85°C, unless otherwise noted. Typical values are at T_A = +25°C.) (Note 1)

PARAMETER	CONDITIONS		MIN	TYP	MAX	UNITS
DC INPUT						
DC Operating Range			4.15		16	V
DC Undervoltage Threshold	When \overline{VDOK} goes low, V _{DC} rising, 500mV typical hysteresis	No valid USB input	3.9	4.0	4.1	V
		Valid USB input	4.0	4.3	4.4	
DC Overvoltage Threshold	When \overline{VDOK} goes high, V _{DC} rising, 500mV typical hysteresis		16.5	17	17.5	V
DC Supply Current	Charger enabled, no switching, V _{SYS} = 5V			2.3	4	mA
	Charger enabled, f = 3MHz, V _{DC} = 5V			15		
	Charger enabled, \overline{VCEN} = 0V, 100mA USB mode (Note 2)			1	2	
	Charger enabled, \overline{VCEN} = 5V, 100mA USB mode (Note 2)			1	2	
	V _{DCM} = 0V, V _{USUS} = 5V			0.10	0.25	
DC High-Side Resistance				0.15		Ω
DC Low-Side Resistance				0.15		Ω
DC-to-BAT Dropout Resistance				0.31		Ω
DC-to-BAT Dropout Voltage	When SYS regulation and charging stops, V _{DC} falling, 200mV hysteresis		0	15	30	mV
Switching Frequency	V _{DC} = 8V, V _{BAT} = 4V			4		MHz
	V _{DC} = 5V, V _{BAT} = 3V			3		
DC Step-Down Output Current-Limit Step Range			0.5		2	A
DC Step-Down Output Current Limit	V _{DC} = 6V, V _{SYS} = 4V	R _{IDC} = 3kΩ	1900	2000	2100	mA
		R _{IDC} = 6kΩ	950	1000	1050	
		R _{IDC} = 12kΩ	450	500	550	
DC Soft-Start Time	No valid USB input			1		ms
	Valid USB input before soft-start			20		μs

2A 1-Cell Li+ DC-DC Charger for USB* and Adapter Power

MAX8903A

ELECTRICAL CHARACTERISTICS (continued)

($V_{DC} = V_{USB} = 5V$, $V_{BAT} = 4V$, circuit of Figure 2, $T_A = -40^{\circ}C$ to $+85^{\circ}C$, unless otherwise noted. Typical values are at $T_A = +25^{\circ}C$.) (Note 1)

PARAMETER	CONDITIONS	MIN	TYP	MAX	UNITS	
DC Output Current 500mA USB Mode (Note 3)	$V_{DCM} = 0V$, $V_{IUSB} = 5V$	450	475	500	mA	
DC Output Current 100mA USB Mode (Note 2)	$V_{DCM} = 0V$, $V_{IUSB} = 0V$	90	95	100	mA	
SYS to DC Reverse Current Blocking	$V_{SYS} = 5.5V$, $V_{DC} = 0V$		0.01		μA	
USB INPUT						
USB Operating Range		4.1		6.3	V	
USB Standoff Voltage				8	V	
USB Undervoltage Threshold	When $\overline{V_{UOK}}$ goes low, V_{USB} rising, 500mV hysteresis	3.95	4.0	4.05	V	
USB Overvoltage Threshold	When $\overline{V_{UOK}}$ goes high, V_{USB} rising, 500mV hysteresis	6.8	6.9	7.0	V	
USB Current Limit	$V_{IUSB} = 0V$ (100mA setting)	90	95	100	mA	
	$V_{IUSB} = 5V$ (500mA setting)	450	475	500		
USB Supply Current	$I_{SYS} = I_{BAT} = 0mA$, $V_{CEN} = 0V$		1.3	3	mA	
	$I_{SYS} = I_{BAT} = 0mA$, $V_{CEN} = 5V$		0.8	2		
	$V_{USUS} = 5V$ (USB suspend mode)		0.115	0.25		
Minimum USB to BAT Headroom		0	15	30	mV	
USB to SYS Dropout Resistance			0.2	0.35	Ω	
USB Soft-Start Time	V_{USB} rising		1		ms	
	V_{DC} falling below DC UVLO to initiate USB soft-start		20		μs	
SYS OUTPUT						
Minimum SYS Regulation Voltage	$I_{SYS} = 1A$, $V_{BAT} < V_{SYS_MIN}$		3.0		V	
Regulation Voltage	$I_{SYS} = 0A$	4.3	4.4	4.5	V	
Load Regulation	$I_{SYS} = 0$ to 2A		40		mV/A	
CS to SYS Resistance	$V_{DC} = 6V$, $V_{DCM} = 5V$, $V_{SYS} = 4V$, $I_{CS} = 1A$		0.07		Ω	
SYS to CS Leakage	$V_{SYS} = 5.5V$, $V_{DC} = V_{CS} = 0V$		0.01		μA	
BAT to SYS Resistance	$V_{DC} = V_{USB} = 0V$, $V_{BAT} = 4.2V$, $I_{SYS} = 1A$		0.05	0.1	Ω	
BAT to SYS Reverse Regulation Voltage	$V_{USB} = 5V$, $V_{DC} = 0V$, $V_{IUSB} = 0V$, $I_{SYS} = 200mA$	50	75	100	mV	
SYS Undervoltage Threshold	SYS falling, 200mV hysteresis (Note 4)	1.8	1.9	2.0	V	
BATTERY CHARGER						
BAT Regulation Voltage	$I_{BAT} = 0mA$	$T_A = +25^{\circ}C$	4.179	4.2	4.221	V
		$T_A = -40^{\circ}C$ to $+85^{\circ}C$	4.158	4.2	4.242	
Charger Restart Threshold	Change in V_{BAT} from DONE to fast-charge	-150	-100	-60	mV	
BAT Prequal Threshold	V_{BAT} rising, 180mV hysteresis	2.9	3	3.1	V	
Prequal Charge Current	Percentage of fast-charge current set at ISET		10		%	

2A 1-Cell Li+ DC-DC Charger for USB* and Adapter Power

ELECTRICAL CHARACTERISTICS (continued)

($V_{DC} = V_{USB} = 5V$, $V_{BAT} = 4V$, circuit of Figure 2, $T_A = -40^{\circ}C$ to $+85^{\circ}C$, unless otherwise noted. Typical values are at $T_A = +25^{\circ}C$.) (Note 1)

PARAMETER	CONDITIONS	MIN	TYP	MAX	UNITS
Fast-Charge Current	$R_{ISET} = 600\Omega$	1800	2000	2200	mA
	$R_{ISET} = 1.2k\Omega$	900	1000	1100	
	$R_{ISET} = 2.4k\Omega$	450	500	550	
DONE Threshold	Percentage of fast-charge, I_{BAT} decreasing		10		%
R_{ISET} Resistor Range		0.6		2.4	k Ω
ISET Output Voltage			1.5		V
ISET Current Monitor Gain			1.25		mA/A
BAT Leakage Current	No DC or USB input		0.05	4	μ A
	With valid input power, $V_{CEN} = 5V$		1	6	
Charger Soft-Start Time			1.0		ms
Charger Thermal Limit Temperature			100		$^{\circ}C$
Charger Thermal Limit Gain	Charge current = 0 at $+120^{\circ}C$		5		%/ $^{\circ}C$
CHARGER TIMER					
Prequalification Time	$C_{CT} = 0.15\mu F$		33		min
Fast-Charge Time	$C_{CT} = 0.15\mu F$		660		min
Timer Accuracy		-15		+15	%
Timer Extend Current Threshold	Percentage of fast-charge current below which the timer clock operates at half-speed	40	50	60	%
Timer Suspend Current Threshold	Percentage of fast-charge current below which timer clock pauses	16	20	24	%
Charge Done Delay Time	From done threshold detection until charger turns off and \overline{CHG} goes high		15		s
THERMISTOR MONITOR					
THM Threshold, Hot	When charging is suspended, 1% hysteresis	0.27 x V_{VL}	0.28 x V_{VL}	0.29 x V_{VL}	V
THM Threshold, Cold	When charging is suspended, 1% hysteresis	0.73 x V_{VL}	0.74 x V_{VL}	0.75 x V_{VL}	V
THM Threshold, Disabled	THM function is disabled below this voltage	0.0254 x V_{VL}	0.03 x V_{VL}	0.036 x V_{VL}	V
THM Input Leakage	THM = GND or VL; $T_A = +25^{\circ}C$	-0.1	+0.001	+0.2	μ A
	THM = GND or VL; $T_A = +85^{\circ}C$		0.01		
THERMAL SHUTDOWN, VL, AND LOGIC I/O: \overline{CHG}, \overline{FLT}, \overline{DOK}, \overline{UOK}, DCM, \overline{CEN}, USUS, IUSB					
Logic-Input Thresholds (DCM, \overline{CEN} , USUS, IUSB)	High level	1.3			V
	Low level	0.4			
	Hysteresis	50			mV
Logic-Input Leakage Current (DCM, \overline{CEN} , USUS, IUSB)	$V_{INPUT} = 0$ to 5.5V	$T_A = +25^{\circ}C$	0.001	1	μ A
		$T_A = +85^{\circ}C$	0.01		

2A 1-Cell Li+ DC-DC Charger for USB* and Adapter Power

MAX8903A

ELECTRICAL CHARACTERISTICS (continued)

($V_{DC} = V_{USB} = 5V$, $V_{BAT} = 4V$, circuit of Figure 2, $T_A = -40^{\circ}C$ to $+85^{\circ}C$, unless otherwise noted. Typical values are at $T_A = +25^{\circ}C$.) (Note 1)

PARAMETER	CONDITIONS	MIN	TYP	MAX	UNITS
Logic Output Voltage, Low (CHG, FLT, DOK, UOK)	Sinking 1mA		8	50	mV
	Sinking 10mA		80		
Open-Drain Output Leakage Current, High (CHG, FLT, DOK, UOK)	$V_{OUT} = 5.5V$	$T_A = +25^{\circ}C$	0.001	1	μA
		$T_A = +85^{\circ}C$	0.01		
VL Output Voltage	$V_{DC} = V_{USB} = 6V$, $I_{VL} = 0$ to 1mA	4.6	5	5.4	V
VL UVLO Threshold	V_{VL} falling; 200mV hysteresis		3.2		V
Thermal Shutdown Temperature			160		$^{\circ}C$
Thermal Shutdown Hysteresis			15		$^{\circ}C$

Note 1: Limits are 100% production tested at $T_A = +25^{\circ}C$. Limits over the operating temperature range are guaranteed by design.

Note 2: For the 100mA USB mode using the DC input, the step-down regulator is turned off and a low-dropout linear regulator is connected from DC to SYS.

Note 3: For the 500mA USB mode, the actual current drawn from USB is less than the output current due to the input/output current ratio of the DC-DC converter.

Note 4: For short-circuit protection, SYS sources 25mA below $V_{SYS} = 400mV$, and 50mA for V_{SYS} between 400mV and 2V.

Typical Operating Characteristics

($T_A = +25^{\circ}C$, unless otherwise noted.)

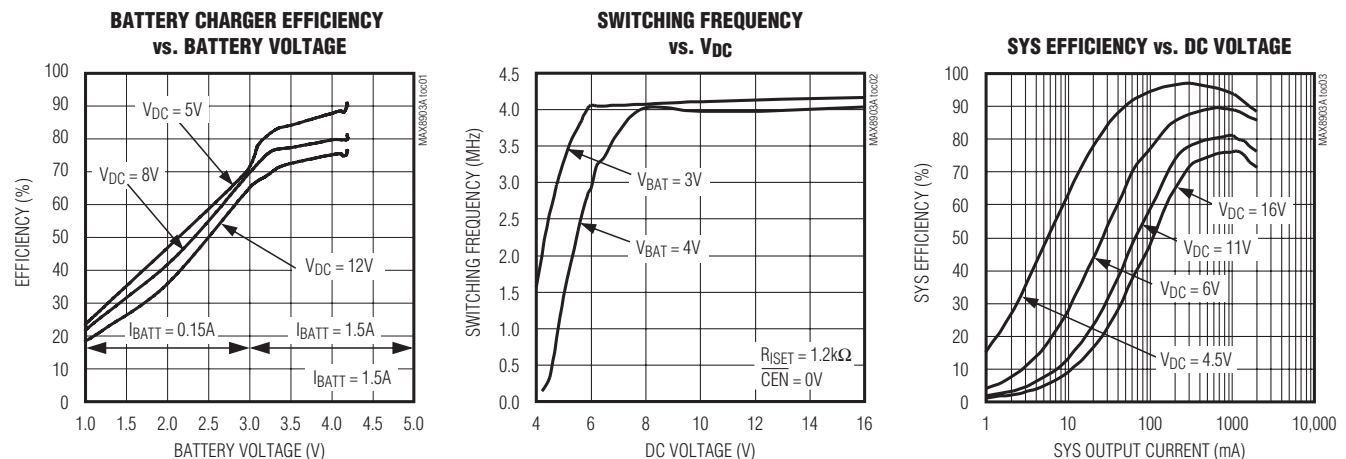

2A 1-Cell Li+ DC-DC Charger for USB* and Adapter Power

Typical Operating Characteristics (continued)

($T_A = +25^\circ\text{C}$, unless otherwise noted.)

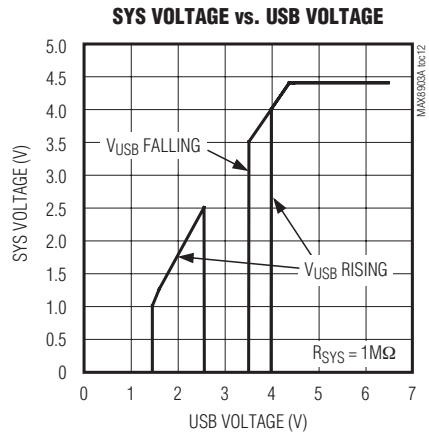
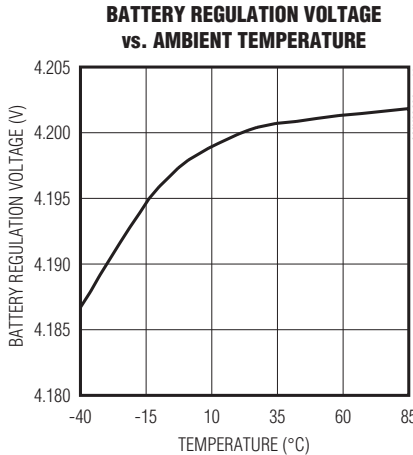
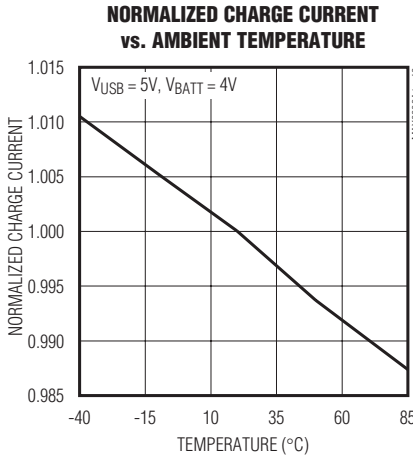
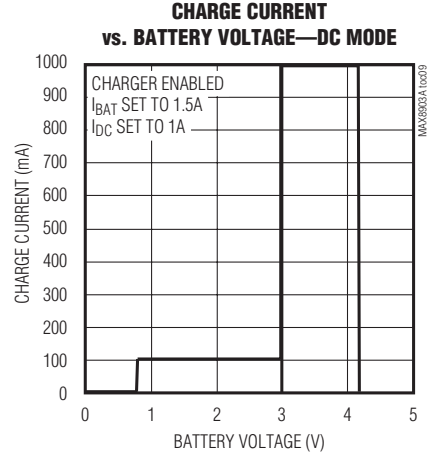
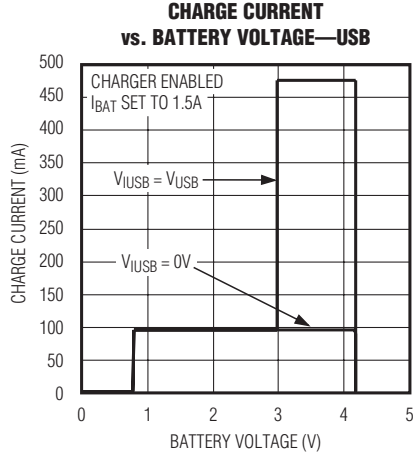
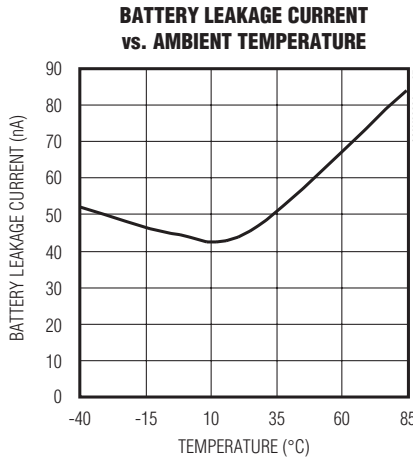
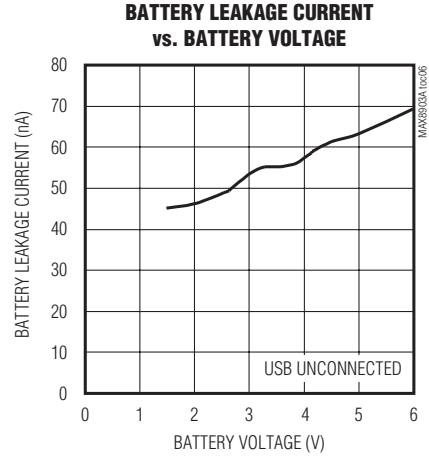
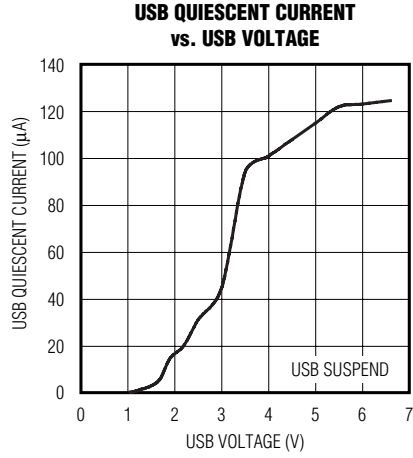
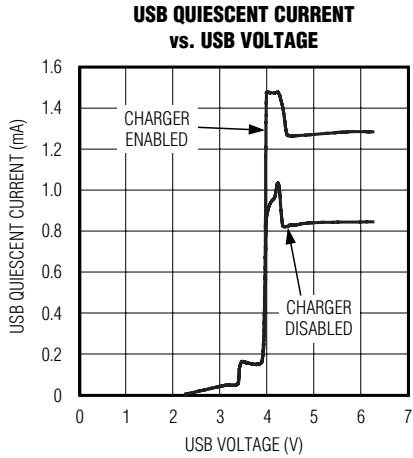

2A 1-Cell Li+ DC-DC Charger for USB* and Adapter Power

Typical Operating Characteristics (continued)

($T_A = +25^\circ\text{C}$, unless otherwise noted.)

MAX8903A

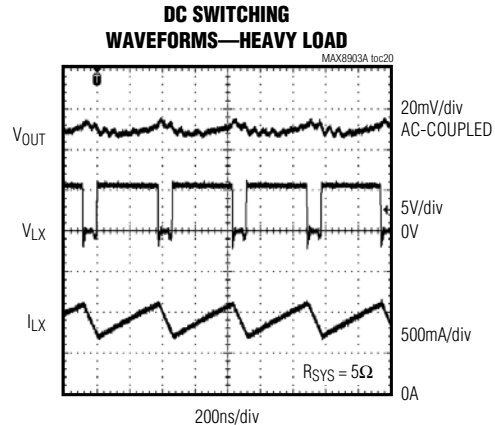
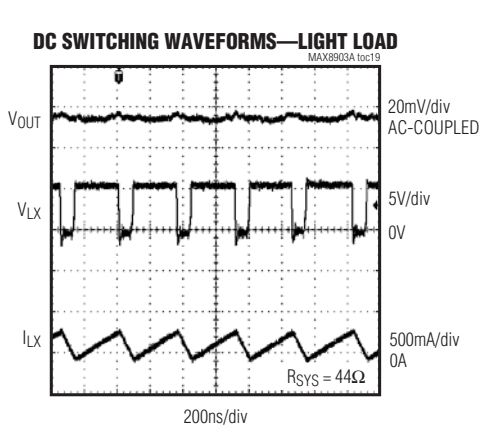
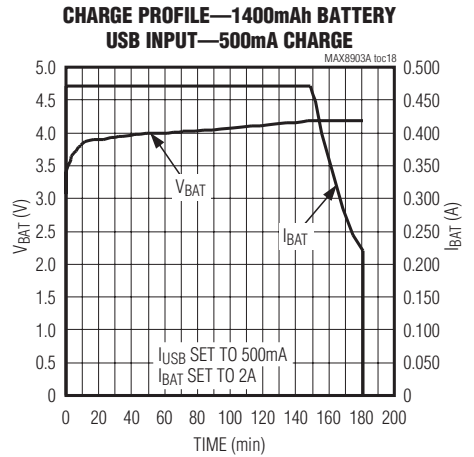
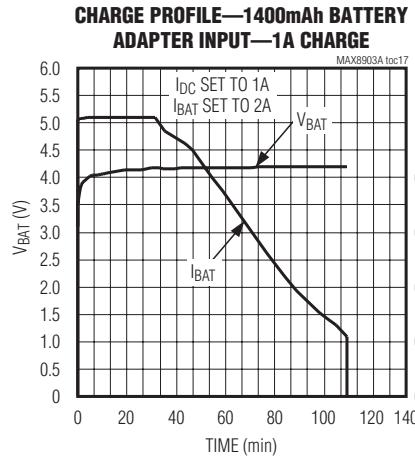
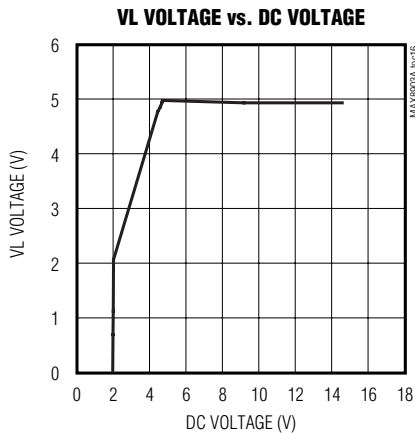
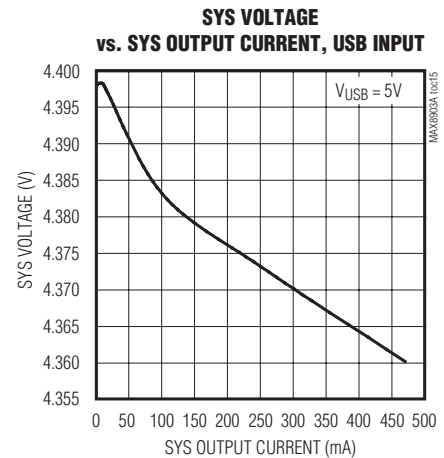
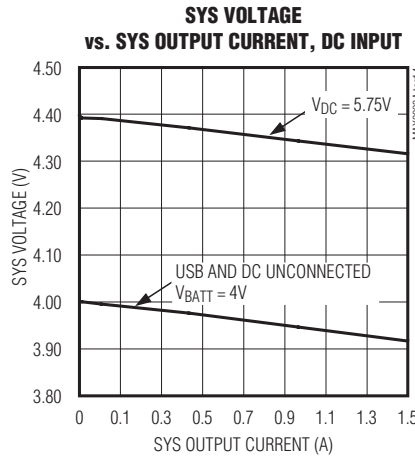
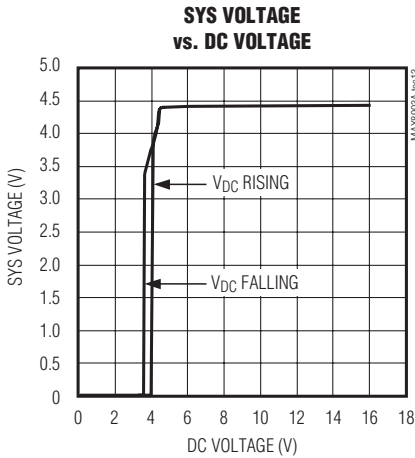

2A 1-Cell Li+ DC-DC Charger for USB* and Adapter Power

Typical Operating Characteristics (continued)

($T_A = +25^\circ\text{C}$, unless otherwise noted.)

DC CONNECT WITH USB CONNECTED ($R_{\text{SYS}} = 25\Omega$)

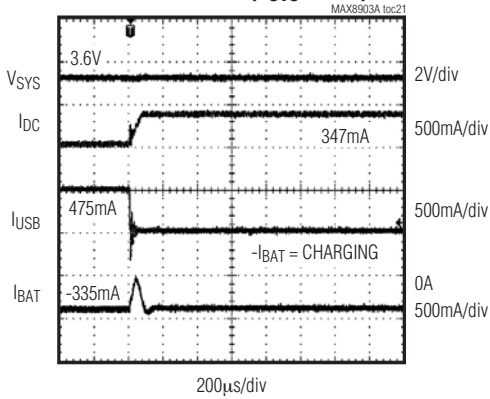

DC CONNECT WITH NO USB ($R_{\text{SYS}} = 25\Omega$)

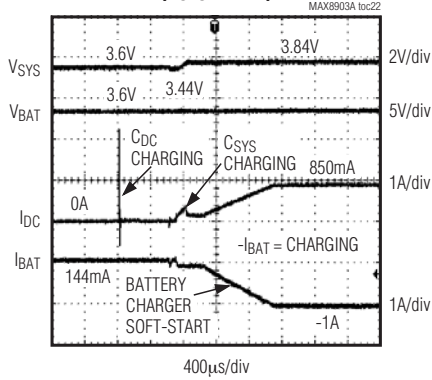

DC DISCONNECT WITH NO USB ($R_{\text{SYS}} = 25\Omega$)

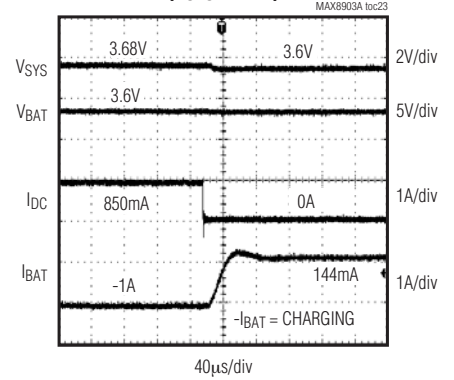

SYS LOAD TRANSIENT (0 TO 1A)

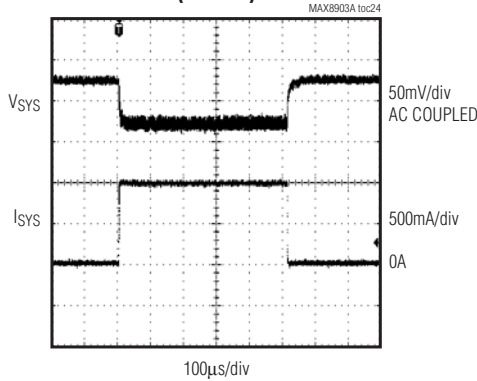

USB CONNECT WITH NO DC ($R_{\text{SYS}} = 25\Omega$)

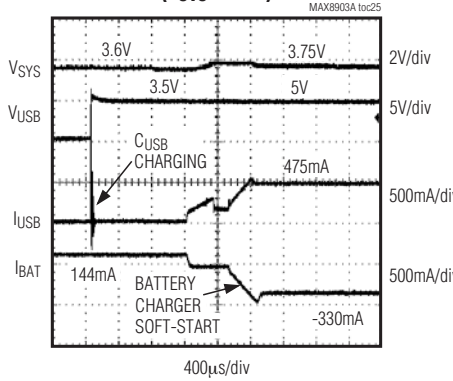

USB DISCONNECT WITH NO DC ($R_{\text{SYS}} = 25\Omega$)

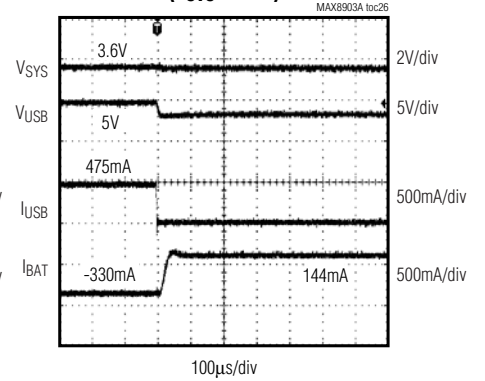

USB SUSPEND

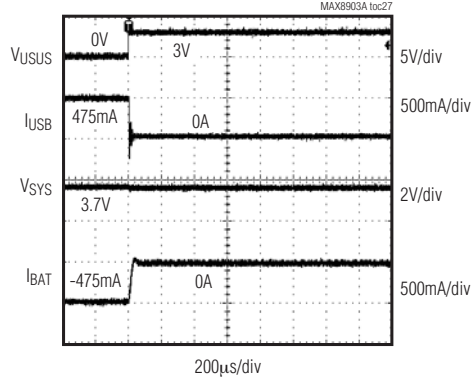

USB RESUME

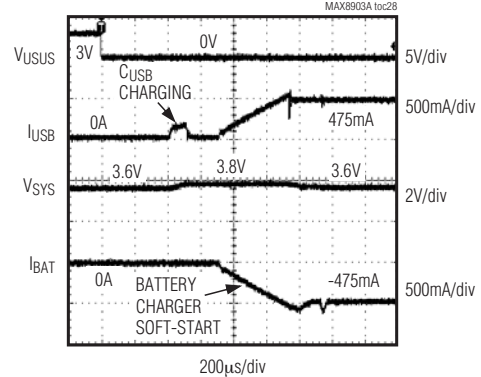

2A 1-Cell Li+ DC-DC Charger for USB* and Adapter Power

Pin Description

MAX8903A

PIN	NAME	FUNCTION
1, 2	PG	Power Ground for Step-Down Low-Side Synchronous n-Channel MOSFET. Both PG pins must be connected together externally.
3, 4	DC	DC Power Input. DC is capable of delivering up to 2A to SYS. DC supports both AC adapter and USB inputs. The DC current limit is set through DCM, IUSB, or IDC depending on the input source used. See Table 2. Both DC pins must be connected together externally. Connect at least a 4.7µF ceramic capacitor from DC to PG.
5	DCM	Current-Limit Mode Setting for the DC Power Input. When logic-high, the DC input current limit is set by the resistor at IDC. When logic-low, the DC input current limit is internally programmed to 500mA or 100mA, as set by the IUSB pin.
6	BST	High-Side MOSFET Driver Supply. Bypass BST to LX with a 0.1µF ceramic capacitor.
7	IUSB	USB Current-Limit Set Input. Drive IUSB logic-low to set the USB current limit to 100mA. Drive IUSB logic-high to set the USB current limit to 500mA.
8	\overline{DOK}	DC Power-OK Output. Active-low open-drain output pulls low when a valid input is detected at DC. \overline{DOK} is still valid when the charger is disabled (\overline{CEN} high).
9	VL	Logic LDO Output. VL is the output of an LDO that powers the MAX8903A internal circuitry and charges the BST capacitor. Connect a 1µF ceramic capacitor from VL to GND.
10	CT	Charge Timer Set Input. A capacitor (C_{CT}) from CT to GND sets the fast-charge and prequal fault timers. Connect to GND to disable the timer.
11	IDC	DC Current-Limit Set Input. Connect a resistor (R_{IDC}) from IDC to GND to program the current limit of the step-down regulator from 0.5A to 2A when DCM is logic-high.
12	GND	Ground. GND is the low-noise ground connection for the internal circuitry.
13	ISET	Charge Current Set Input. A resistor (R_{ISET}) from ISET to GND programs the fast-charge current up to 2A. The prequal charge current is 10% of the fast-charge current.
14	\overline{CEN}	Charger Enable Input. Connect \overline{CEN} to GND to enable battery charging when a valid source is connected at DC or USB. Connect to VL, or drive high to disable battery charging.
15	USUS	USB Suspend Input. Drive USUS logic-high to enter USB suspend mode, lowering USB current to 115µA, and internally shorting SYS to BAT.
16	THM	Thermistor Input. Connect a negative temperature coefficient (NTC) thermistor from THM to GND. Connect a resistor equal to the thermistor +25°C resistance from THM to VL. Charging is suspended when the thermistor is outside the hot and cold limits. Connect THM to GND to disable the thermistor temperature sensor.
17	USB	USB Power Input. USB is capable of delivering 100mA or 500mA to SYS as set by the IUSB logic input. Connect a 4.7µF ceramic capacitor from USB to GND.
18	\overline{FLT}	Fault Output. Active-low, open-drain output pulls low when the battery timer expires before prequal or fast-charge completes.
19	\overline{UOK}	USB Power-OK Output. Active-low, open-drain output pulls low when a valid input is detected at USB. \overline{UOK} is still valid when the charger is disabled (\overline{CEN} high).
20, 21	BAT	Battery Connection. Connect to a single-cell Li+ battery. The battery charges from SYS when a valid source is present at DC or USB. BAT powers SYS when neither DC nor USB power is present, or when the SYS load exceeds the input current limit. Both BAT pins must be connected together externally.

2A 1-Cell Li+ DC-DC Charger for USB* and Adapter Power

Pin Description (continued)

PIN	NAME	FUNCTION
22	$\overline{\text{CHG}}$	Charger Status Output. Active-low, open-drain output pulls low when the battery is in fast-charge or prequal. Otherwise, $\overline{\text{CHG}}$ is high impedance.
23, 24	SYS	System Supply Output. SYS connects to BAT through an internal 50m Ω system load switch when DC or USB are invalid, or when the SYS load is greater than the input current limit. When a valid voltage is present at DC or USB, SYS is limited to 4.4V. When the system load (I_{SYS}) exceeds the DC or USB current limit, SYS is regulated to 50mV below BAT, and both the powered input and the battery service SYS. Bypass SYS to GND with a 10 μ F X5R or X7R ceramic capacitor. Both SYS pins must be connected together externally.
25, 26	CS	70m Ω Current-Sense Input. Connect the step-down inductor from LX to CS. When the step-down regulator is on, there is a 70m Ω current-sense MOSFET from CS to SYS. When the step-down regulator is off, the internal CS MOSFET turns off to block current from SYS back to DC.
27, 28	LX	Inductor Connection. Connect the inductor between LX and CS. Both LX pins must be connected together externally.
—	EP	Exposed Pad. Connect the exposed pad to GND. Connecting the exposed pad does not remove the requirement for proper ground connections to the appropriate pins.

2A 1-Cell Li+ DC-DC Charger for USB* and Adapter Power

MAX8903A

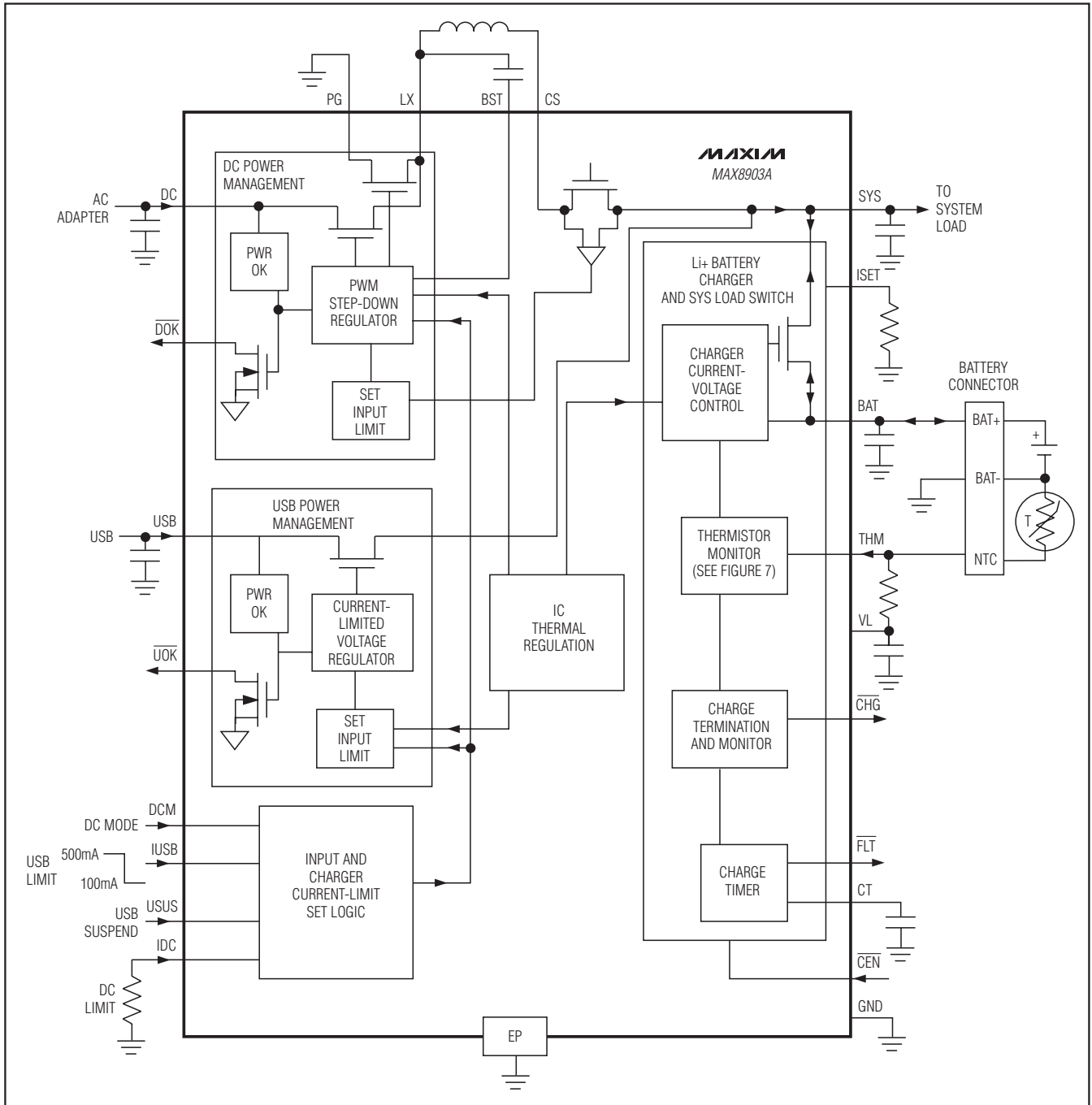

Figure 1. Functional Block Diagram

2A 1-Cell Li+ DC-DC Charger for USB* and Adapter Power

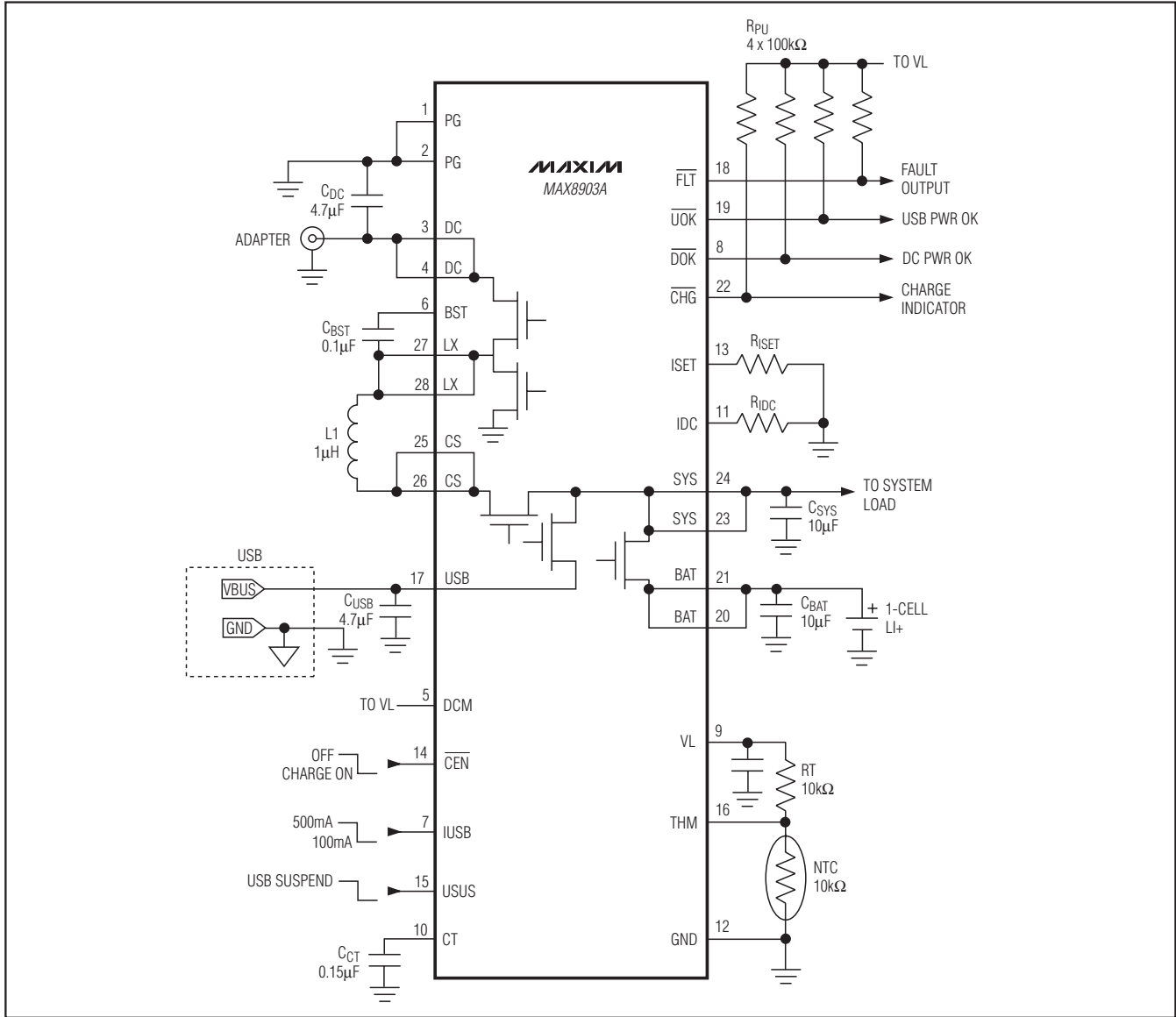

Figure 2. Typical Application Circuit Using a Separate DC and USB Connector

Circuit Description

The MAX8903A is a dual input charger with a 16V input for a wide range of DC sources and USB inputs. The IC includes a high-voltage (16V) input DC-DC step-down converter that reduces charger power dissipation while also supplying power to the system load. The step-down converter supplies up to 2A to the system, the battery, or a combination of both.

A USB charge input can charge the battery and power the system from a USB power source. When powered from USB or the DC input, system load current peaks that exceed what can be supplied by the input are supplemented by the battery.

The MAX8903A also manages load switching from the battery to and from an external power source with an on-chip 50mΩ MOSFET. This switch also helps support load peaks using battery power when the input source is overloaded.

2A 1-Cell Li+ DC-DC Charger for USB* and Adapter Power

MAX8903A

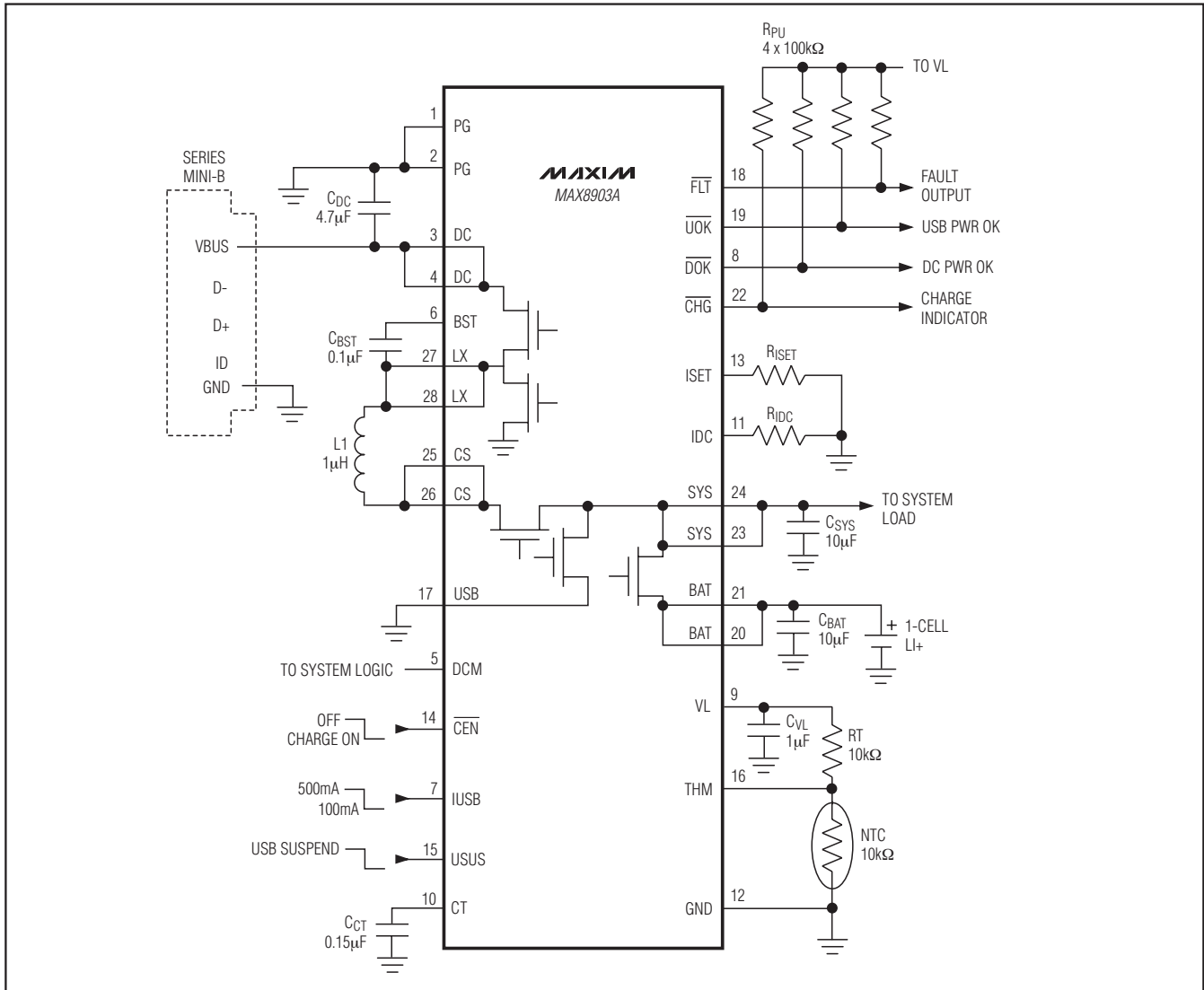

Figure 3. Typical Application Circuit Using a Mini 5 Style Connector or Other DC/USB Common Connector

The IC includes a full-featured charger with thermistor monitor, fault timer, charger status, and fault outputs. Also included are power-OK signals for both USB and DC. Flexibility is maintained with adjustable charge current, input current limit, and a minimum system voltage (when charging is scaled back to hold the system voltage up).

The MAX8903A prevents overheating during high ambient temperatures by limiting charging current when the die temperature exceeds +100°C.

DC Input—Fast Hysteretic Step-Down Regulator

If a valid DC input is present, the USB power path is turned off and power for SYS and battery charging is supplied by the high-frequency step-down regulator from DC. If the battery voltage is above the minimum system voltage ($V_{SYSTEMIN}$, Figure 4), the battery charger connects the system voltage to the battery for lowest power dissipation. The step-down regulation point is then controlled by three feedback signals: maximum

2A 1-Cell Li+ DC-DC Charger for USB* and Adapter Power

Table 1. External Components List for Figures 2 and 3

COMPONENT (FIGURES 2 AND 3)	FUNCTION	PART
C _{DC} , C _{USB}	Input filter capacitor	4.7µF ceramic capacitor
C _{VL}	VL filter capacitor	1.0µF ceramic capacitor
C _{SYS}	SYS output bypass capacitor	10µF ceramic capacitor
C _{BAT}	Battery bypass capacitor	10µF ceramic capacitor
C _{CT}	Charger timing capacitor	0.15µF low TC ceramic capacitor
R _{PU} (X4)	Logic output pullup resistors	100kΩ
THM	Negative TC thermistor	Phillips NTC thermistor, P/N 2322-640-63103, 0kΩ ±5% at +25°C
R _T	THM pullup resistor	10kΩ
R _{IDC}	DC input current-limit programming resistor	3kΩ ±1%, for 2A limit
R _{ISET}	Fast-charge current programming resistor	1.2kΩ ±1%, for 1A charging
L1	DC input step-down inductor	1µH inductor with I _{SAT} > 2A

step-down output current programmed at IDC, maximum charger current programmed at ISET, and maximum die temperature. The feedback signal requiring the smallest current controls the average output current in the inductor. This scheme minimizes total power dissipation for battery charging and allows the battery to absorb any load transients with minimum system voltage disturbance.

If the battery voltage is below V_{SYSTEMIN}, the charger does not directly connect the system voltage to the battery. V_{SYS} pin is held at a fixed point slightly above V_{SYSTEMIN}, and does not track the battery. The battery charger independently controls the battery charging current. V_{SYSTEMIN} is set to 3.0V in the MAX8903A, for other V_{SYSTEMIN} values, please contact the factory.

After the battery charges to 50mV above V_{SYSTEMIN}, the system voltage is connected to the battery. The battery fast-charge current then controls the step-down converter to set the average inductor current so that both the programmed input current limit and fast-charge current limit are satisfied.

DC-DC Step-Down Control Scheme

A proprietary hysteretic current PWM control scheme ensures fast switching and physically tiny external components. The feedback control signal that requires the smallest input current controls the center of the peak and valley currents in the inductor. The ripple current is internally set to provide 4MHz operation. When the input voltage decreases near the output voltage, very high duty cycle occurs and, due to minimum off-time, 4MHz operation is not achievable. The controller then provides minimum off-time, peak current regulation.

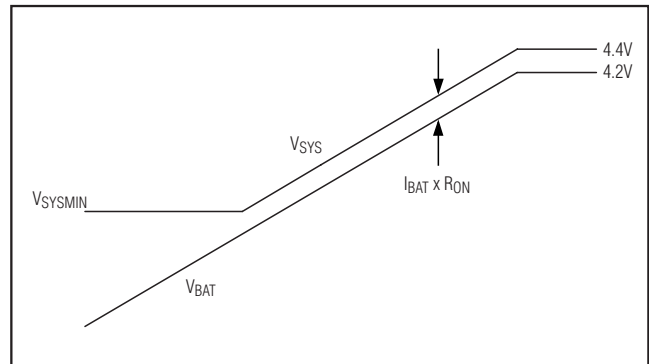

Figure 4. SYS Tracking V_{BAT} to the Minimum System Voltage

Similarly, when the input voltage is too high to allow 4MHz operation due to the minimum on-time, the controller becomes a minimum on-time, valley current regulator. In this way, ripple current in the inductor is always as small as possible to reduce ripple voltage on SYS for a given capacitance. The ripple current is made to vary with input voltage and output voltage in a way that reduces frequency variation. However, the frequency still varies somewhat with operating conditions. See the *Typical Operating Characteristics*.

DC Input—USB mode

When powering from DC with DCM set to logic-low, the DC input is set to USB mode. The input current limit from DC is then internally set to 500mA max if I_{USB} is high and 100mA max if I_{USB} is low. For the 500mA case, the DC input continues to operate as a step-down regulator to minimize thermal heating. For the 100mA case, the

2A 1-Cell Li+ DC-DC Charger for USB* and Adapter Power

MAX8903A

step-down regulator is turned off and a low-dropout linear regulator is connected between DC and SYS.

USB Input—Linear Regulator

If a valid USB input is present with no valid DC input, current for SYS and battery charging is supplied by a low-dropout linear regulator connected from USB to SYS. The SYS regulation voltage shows the same characteristic as when powering from the DC input (see Figure 4). The battery charger operates from SYS with any extra available current, while not exceeding the maximum-allowed USB current. If both USB and DC inputs are valid, power is only taken from the DC input. The maximum USB input current is set by the logic state of the IUSB input to either 100mA or 500mA.

Power Monitor Outputs (\overline{UOK} , \overline{DOK})

\overline{DOK} is an open-drain, active-low output that indicates the DC input power status. With no source at the USB pin, the source at DC is considered valid and \overline{DOK} is driven low when: $4.15V < V_{DC} < 16V$. When the USB voltage is also valid, the DC source is considered valid and \overline{DOK} is driven low when: $4.45V < V_{DC} < 16V$. The higher minimum DC voltage with USB present helps guarantee cleaner transitions between input supplies. If the DC power-OK output feature is not required, connect \overline{DOK} to ground.

\overline{UOK} is an open-drain, active-low output that indicates the USB input power status. \overline{UOK} is low when a valid source is connected at USB. The source at USB is valid when $4.1V < V_{USB} < 6.6V$. If the USB power-OK output feature is not required, connect \overline{UOK} to ground.

Both the \overline{UOK} and the \overline{DOK} circuitry remain active in thermal overload, USB suspend, and when the charger is disabled. \overline{DOK} and \overline{UOK} can also be wire-ORed together to generate a single power-OK (POK) output.

Thermal Limiting

When the die temperature exceeds $+100^{\circ}\text{C}$, a thermal limiting circuit reduces the input current limit by $5\%/^{\circ}\text{C}$, bringing the charge current to 0mA at $+120^{\circ}\text{C}$. Since the system load gets priority over battery charging, the battery charge current is reduced to 0mA before the input limiter drops the load voltage at SYS. To avoid false charge termination, the charge termination detect function is disabled in this mode. If the junction temperature rises beyond $+120^{\circ}\text{C}$, no current is drawn from DC or USB, and V_{SYS} regulates at 50mV below V_{BAT} .

System Voltage Switching

DC Input

When charging from the DC input, if the battery is above the minimum system voltage, SYS is connected

to the battery. Current is provided to both SYS and the battery, up to the maximum program value. The step-down output current sense and the charger current sense provide feedback to ensure the current loop demanding the lower input current is satisfied. The advantage of this approach when powering from DC is that power dissipation is dominated by the step-down regulator efficiency, since there is only a small voltage drop from SYS to BAT. Also, load transients can be absorbed by the battery while minimizing the voltage disturbance on SYS. If both the DC and USB inputs are valid, the DC input takes priority and delivers the input current, while the USB input is off.

After the battery is done charging, the charger is turned off and the SYS load current is supplied from the DC input. The SYS voltage is regulated to 4.4V. The charger turns on again after the battery drops to the restart threshold. If the load current exceeds the input limiter, SYS drops down to the battery voltage and the 50m Ω SYS-to-BAT PMOS switch turns on to supply the extra load current. The SYS-to-BAT switch turns off again once the load is below the input current limit. The 50m Ω PMOS also turns on if valid DC input power is removed.

USB Input

When charging from the USB input, the DC input step-down regulator turns off and a linear regulator from USB to SYS powers the system and charges the battery. If the battery is greater than the minimum system voltage, the SYS voltage is connected to the battery. The USB input then supplies the SYS load and charges the battery with any extra available current, while not exceeding the maximum-allowed USB current. Load transients can be absorbed by the battery while minimizing the voltage disturbance on SYS. When battery charging is completed, or the charger is disabled, SYS is regulated to 4.4V. If both USB and DC inputs are valid, power is only taken from the DC input.

USB Suspend

Driving USUS high turns off charging as well as the SYS output and reduces input current to 170 μA to accommodate USB suspend mode.

Charge Enable (\overline{CEN})

When \overline{CEN} is low, the charger is on. When \overline{CEN} is high, the charger turns off. \overline{CEN} does not affect the SYS output. In many systems, there is no need for the system controller (typically a microprocessor) to disable the charger, because the MAX8903A smart power selector circuitry independently manages charging and adapter/battery power hand-off. In these situations, \overline{CEN} may be connected to ground.

2A 1-Cell Li+ DC-DC Charger for USB* and Adapter Power

Table 2. Input Limiter Control Logic

POWER SOURCE	$\overline{\text{DOK}}$	$\overline{\text{UOK}}$	DCM	IUSB	USUS	DC STEP-DOWN OUTPUT CURRENT LIMIT	USB INPUT CURRENT LIMIT	MAXIMUM CHARGE CURRENT**
AC Adapter at DC Input	L	X	H	X	X	6000/R _{IDC}	USB input off. DC input has priority.	Lesser of 1200/R _{ISET} and 6000/R _{IDC}
USB Power at DC Input	L	X	L	L	L	100mA		Lesser of 1200/R _{ISET} and 100mA
	L	X	L	H	L	500mA		Lesser of 1200/R _{ISET} and 500mA
	L	X	L	X	H	USB suspend		0
USB Power at USB Input, DC Unconnected	H	L	X	L	L	No DC input	100mA	Lesser of 1200/R _{ISET} and 100mA
	H	L	X	H	L		500mA	Lesser of 1200/R _{ISET} and 500mA
	H	L	X	X	H		USB suspend	0
DC and USB Unconnected	H	H	X	X	X		No USB input	0

**Charge current cannot exceed the input current limit. Charge may be less than the maximum charge current if the total SYS load exceeds the input current limit.

X = Don't care.

Soft-Start

To prevent input transients that can cause instability in the USB or AC adapter power source, the rate of change of the input current and charge current is limited. When an input source is valid, SYS current is ramped from zero to the set current-limit value in typically 50 μ s. This also means that if DC becomes valid after USB, the SYS current limit is ramped down to zero before switching from the USB to DC input. At some point, SYS is no longer able to support the load and may switch over to BAT. The switchover to BAT occurs when $V_{\text{SYS}} < V_{\text{BATT}}$. This threshold is a function of the SYS capacitor size and SYS load. The SYS current limit then ramps from zero to the set current level and SYS supports the load again as long as the SYS load current is less than the set current limit.

When the charger is turned on, the charge current ramps from 0A to the ISET current value in typically 1.0ms. Charge current also soft-starts when transitioning to fast-charge from prequal, when the input power source is switched between USB and DC, and when changing the

USB charge current from 100mA to 500mA with the IUSB logic input. There is no di/dt limiting, however, if R_{ISET} is changed suddenly using a switch.

Battery Charger

While a valid input source is present, the battery charger can attempt to charge the battery with a fast-charge current determined by the resistance at the ISET pin:

$$R_{\text{ISET}} = 1200/I_{\text{CHG-MAX}}$$

Monitoring Charge Current

The voltage from ISET to GND is a representation of the battery charge current and can be used to monitor the current charging the battery. A voltage of 1.5V represents the maximum fast-charge current.

If necessary, the charge current is reduced automatically to prevent the SYS voltage from dropping. Therefore, a battery never charges at a rate beyond the capabilities of a 100mA or 500mA USB input, or overloads an AC adapter. See Figure 5.

2A 1-Cell Li+ DC-DC Charger for USB* and Adapter Power

MAX8903A

When V_{BATT} is below 3V, the charger enters prequal mode and the battery charges at 10% of the maximum fast-charge rate until the voltage of the deeply discharged battery recovers. When the battery voltage reaches 4.2V and the charge current drops to 10% of the maximum fast-charge current, the charger enters the DONE state. The charger restarts a fast-charge cycle if the battery voltage drops by 100mV.

Charge Termination

When the charge current falls to the termination threshold (I_{TERM}) and the charger is in voltage mode, charging is complete. Charging continues for a brief 15s top-off period and then enters the DONE state where charging stops.

Note that if charge current falls to I_{TERM} as a result of the input or thermal limiter, the charger does not enter DONE. For the charger to enter DONE, charge current must be less than I_{TERM} , the charger must be in voltage mode, and the input or thermal limiter must not be reducing charge current.

Charge Status Outputs

Charge Output (\overline{CHG})

\overline{CHG} is an open-drain, active-low output that indicates charger status. \overline{CHG} is low when the battery charger is in its prequalification and fast-charge states. \overline{CHG} goes high impedance if the thermistor causes the charger to go into temperature suspend mode.

When used in conjunction with a microprocessor (μP), connect a pullup resistor between \overline{CHG} and the logic I/O voltage to indicate charge status to the μP . Alternatively, \overline{CHG} can sink up to 20mA for an LED charge indicator.

Fault Output (\overline{FLT})

\overline{FLT} is an open-drain, active-low output that indicates charger status. \overline{FLT} is low when the battery charger has entered a fault state when the charge timer expires. This can occur when the charger remains in its prequal state for more than 33 minutes or if the charger remains in fast-charge state for more than 660 minutes (see Figure 6). To exit this fault state, toggle \overline{CEN} or remove and reconnect the input source.

When used in conjunction with a microprocessor (μP), connect a pullup resistor between \overline{FLT} and the logic I/O voltage to indicate charge status to the μP . Alternatively, \overline{FLT} can sink up to 20mA for an LED fault indicator. If the \overline{FLT} output is not required, connect \overline{FLT} to ground or leave unconnected.

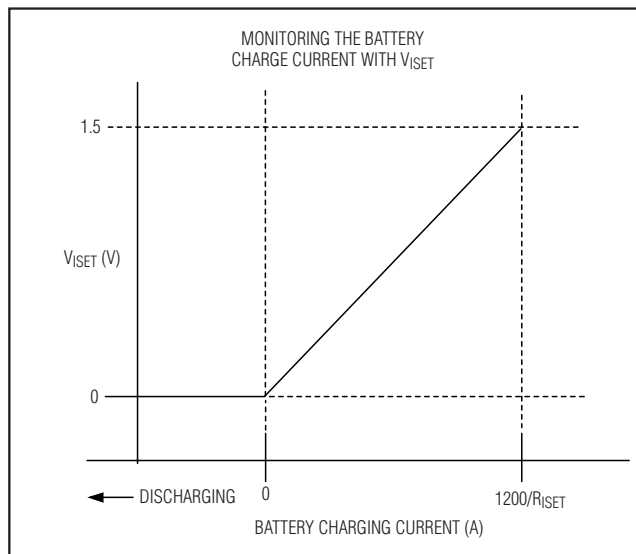

Figure 5. Monitoring the Battery Charge Current with the Voltage from ISET to GND

Charge Timer

A fault timer prevents the battery from charging indefinitely. The fault prequal and fast-charge timers are controlled by the capacitance at CT (C_{CT}).

$$t_{PREQUAL} = 33\text{min} \times \frac{C_{CT}}{0.15\mu\text{F}}$$

$$t_{FST-CHG} = 660\text{min} \times \frac{C_{CT}}{0.15\mu\text{F}}$$

$$t_{TOP-OFF} = 15\text{s}$$

While in fast-charge mode, a large system load or device self-heating may cause the MAX8903A to reduce charge current. Under these circumstances, the fast-charge timer is slowed by 2x if the charge current drops below 50% of the programmed fast-charge level, and suspended if the charge current drops below 20% of the programmed level. The fast-charge timer is not affected at any current if the charger is regulating the BAT voltage at 4.2V (i.e., the charger is in voltage mode).

Thermistor Input (THM)

The THM input connects to an external negative temperature coefficient (NTC) thermistor to monitor battery or system temperature. Charging is suspended when the thermistor temperature is out of range. The charge timers are suspended and hold their state but no fault is indicated. When the thermistor comes back into range,

2A 1-Cell Li+ DC-DC Charger for USB* and Adapter Power

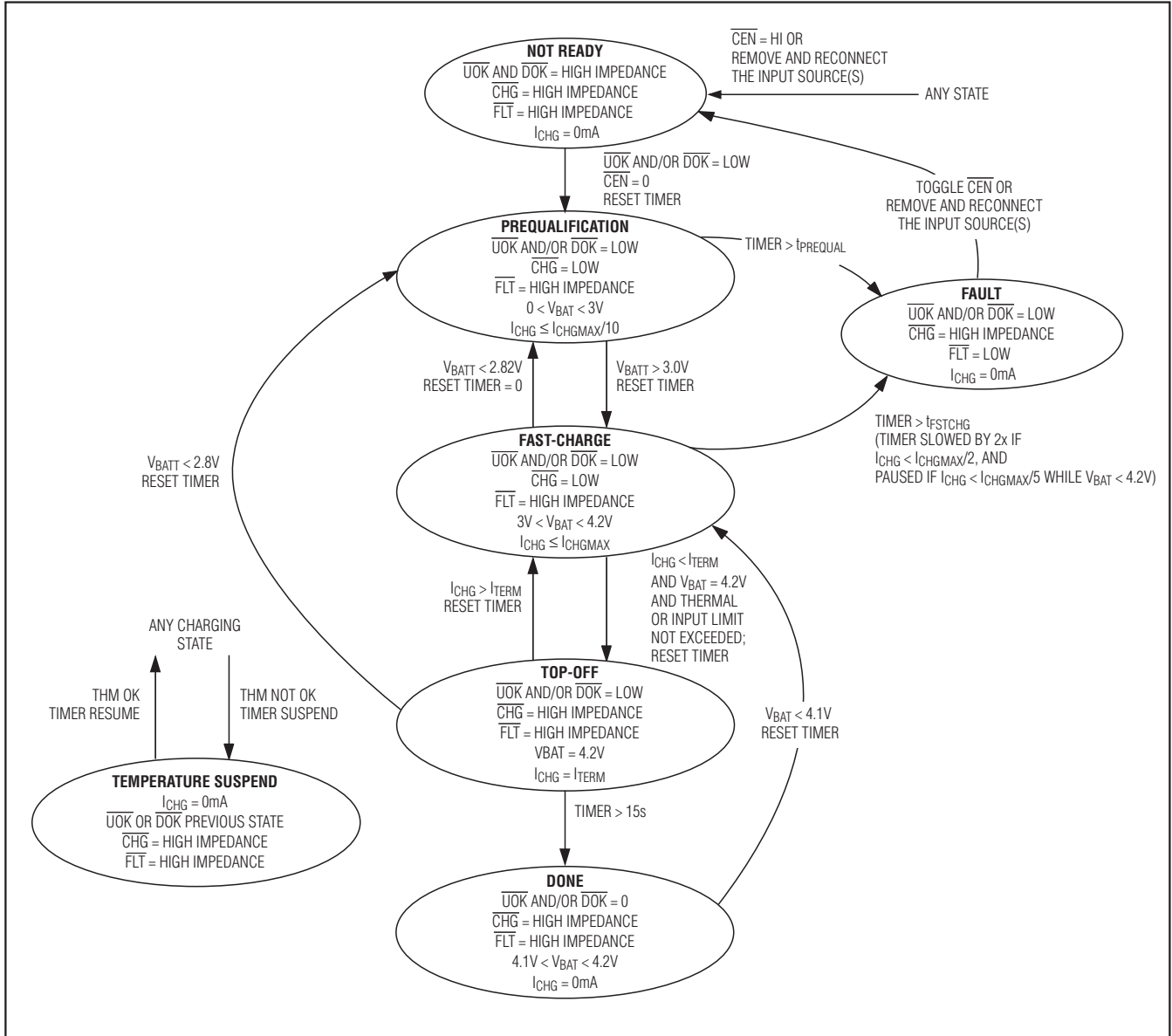

Figure 6. MAX8903A Charger State Flow Chart

charging resumes and the charge timer continues from where it left off. Connecting THM to GND disables the thermistor monitoring function. Table 4 lists the fault temperature of different thermistors.

Since the thermistor monitoring circuit employs an external bias resistor from THM to VL (RTB, Figure 7), the thermistor is not limited only to 10kΩ (at +25°C).

Any resistance thermistor can be used as long as the value is equivalent to the thermistor's +25°C resistance. For example, with a 10kΩ at +25°C thermistor, use 10kΩ at RTB, and with a 100kΩ at +25°C thermistor, use 100kΩ .

For a typical 10kΩ (at +25°C) thermistor and a 10kΩ RTB resistor, the charger enters a temperature suspend

2A 1-Cell Li+ DC-DC Charger for USB* and Adapter Power

MAX8903A

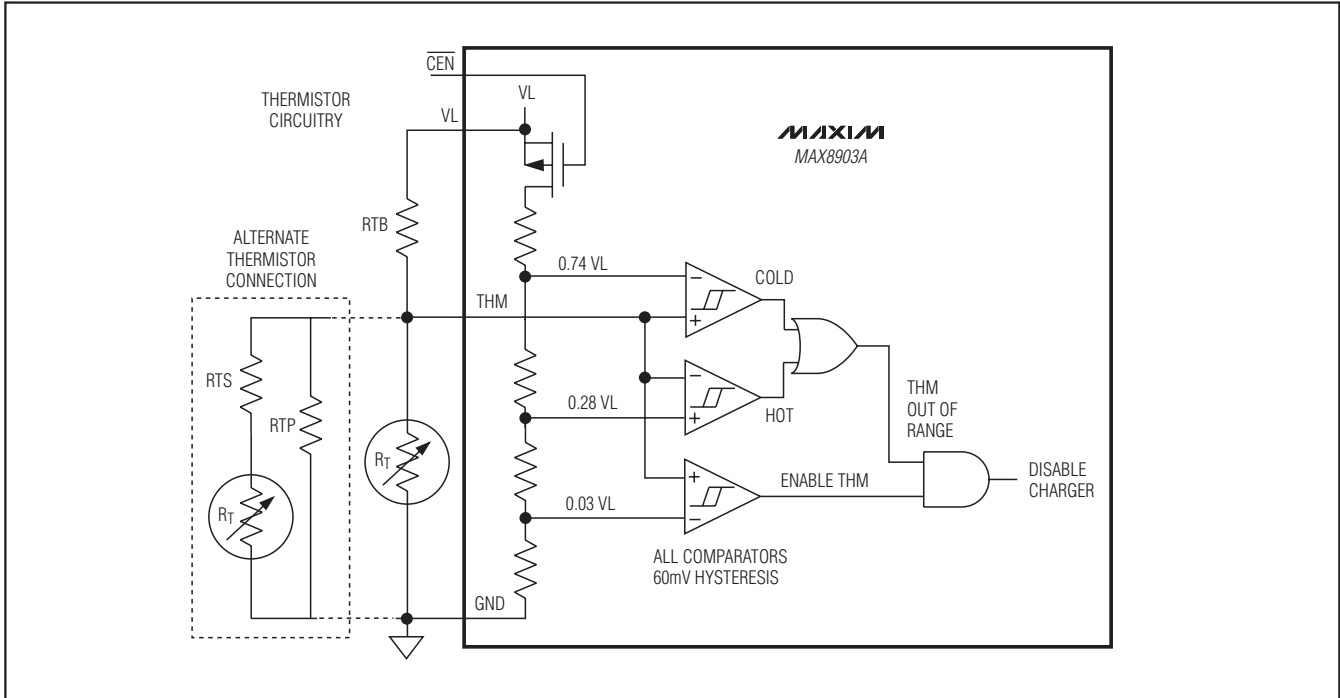

Figure 7. Thermistor Monitor Circuitry

Table 3. Fault Temperatures for Different Thermistors

Thermistor β (K)	3000	3250	3500	3750	4250
R_{TB} (k Ω) (Figure 7)	10	10	10	10	10
Resistance at +25°C (k Ω)	10	10	10	10	10
Resistance at +50°C (k Ω)	4.59	4.30	4.03	3.78	3316
Resistance at 0°C (k Ω)	25.14	27.15	29.32	31.66	36.91
Nominal Hot Trip Temperature (°C)	55	53	50	49	46
Nominal Cold Trip Temperature (°C)	-3	-1	0	2	4.5

state when the thermistor resistance falls below 3.97k Ω (too hot) or rises above 28.7k Ω (too cold). This corresponds to a 0°C to +50°C range when using a 10k Ω NTC thermistor with a beta of 3500. The general relation of thermistor resistance to temperature is defined by the following equation:

$$R_T = R_{25} \times e^{\left\{ \beta \left(\frac{1}{T+273} - \frac{1}{298} \right) \right\}}$$

where:

R_T = The resistance in Ω of the thermistor at temperature T in Celsius

R_{25} = The resistance in Ω of the thermistor at +25°C

β = The material constant of the thermistor, which typically ranges from 3000K to 5000K

T = The temperature of the thermistor in °C

Table 4 shows the MAX8903A THM temperature limits for different thermistor material constants.

Some designs might prefer other thermistor temperature limits. Threshold adjustment can be accommodated by changing R_{TB} , connecting a resistor in series and/or in parallel with the thermistor, or using a thermistor with different β . For example, a +45°C hot threshold and 0°C cold threshold can be realized by using a thermistor with a β of 4250 and connecting 120k Ω in parallel. Since the thermistor resistance near 0°C is much higher than it is near +50°C, a large parallel resistance lowers the cold threshold, while only slightly lowering the hot threshold. Conversely, a small series resistance

2A 1-Cell Li+ DC-DC Charger for USB* and Adapter Power

raises the cold threshold, while only slightly raising the hot threshold. Raising R_{TB} lowers both the hot and cold thresholds, while lowering R_{TB} raises both thresholds.

Note that since VL is active whenever valid input power is connected at DC or USB, thermistor bias current flows at all times, even when charging is disabled (\overline{CEN} = high). When using a 10k Ω thermistor and a 10k Ω pullup to VL, this results in an additional 250 μ A load. This load can be reduced to 25 μ A by instead using a 100k Ω thermistor and 100k Ω pullup resistor.

Power Dissipation

Table 4. Package Thermal Characteristics

	28-PIN 4mm x 4mm THIN QFN	
	SINGLE-LAYER PCB	MULTILAYER PCB
Continuous Power Dissipation	1666.7mW Derate 20.8mW/°C above +70°C	2286mW Derate 28.6mW/°C above +70°C
θ_{JA}	48°C/W	35°C/W
θ_{JC}	3°C/W	3°C/W

PCB Layout and Routing

Good design minimizes ground bounce and voltage gradients in the ground plane, which can result in instability or regulation errors. The GND and PGs should connect to the power-ground plane at only one point to minimize the effects of power-ground currents. Battery ground should connect directly to the power-ground plane. The ISET and IDC current-setting resistors should connect directly to GND to avoid current errors. Connect GND to the exposed pad directly under the IC. Use multiple tightly spaced vias to the ground plane under the exposed pad to help cool the IC. Position input capacitors from DC, SYS, BAT, and USB to the power-ground plane as close as possible to the IC. Keep high current traces such as those to DC, SYS, and BAT as short and wide as possible. Refer to the MAX8903A Evaluation Kit for a suitable PCB layout example.

Pin Configuration

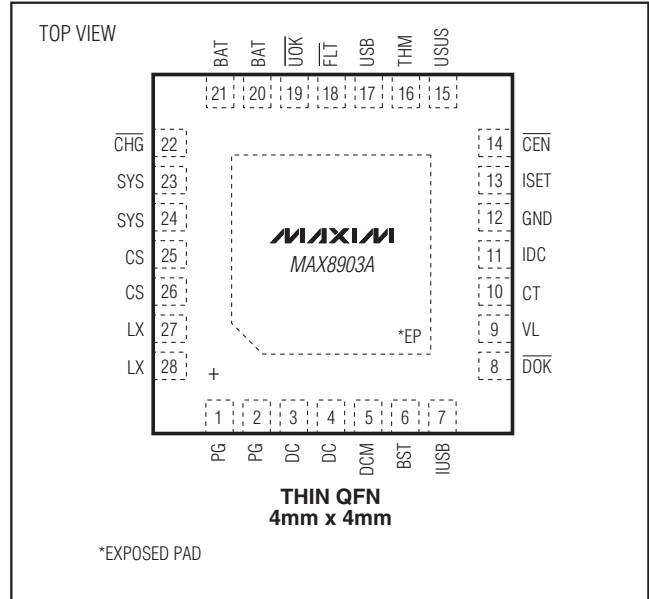

Chip Information

PROCESS: BiCMOS

Package Information

For the latest package outline information and land patterns, go to www.maxim-ic.com/packages.

PACKAGE TYPE	PACKAGE CODE	DOCUMENT NO.
28 TQFN-EP	T2844-1	21-0139

Maxim cannot assume responsibility for use of any circuitry other than circuitry entirely embodied in a Maxim product. No circuit patent licenses are implied. Maxim reserves the right to change the circuitry and specifications without notice at any time.